Chapter 2

Internal Kiln Fittings

Kiln Chain Systems

A. Obrist
PT 96/ 14036 / E

1. INTRODUCTION	179
2. Functions of a Kiln Chain System.....	179
2.1 Heat Exchange.....	179
2.2 Cleaning of the Kiln Shell.....	180
2.3 Transport of Material	180
2.4 Reduce Dust Emissions.....	181
3. Individual Zones of a Chain System.....	181
3.1 Free Zone of the Kiln Inlet	181
3.2 Dust Curtain Zone	181
3.3 Plastic Zone.....	182
3.4 Granular Zone (Preheating Zone).....	182
3.5 Heat Resistant Zone.....	182
1.6 Main Characteristic Data of the Individual Chain System Zones.....	183
4. Arrangement of Chains	183
4.1 Straight Curtain	183
4.2 Spiral Zone	184
1.3 Multiple Spiral Curtain.....	185
1.4 Triangular Curtain (Z-Curtain).....	186
1.5 Garlands.....	187
1.6 Festoons	188
1.7 Spiral Garlands.....	188
1.8 Thermochains.....	189
5. Types of Chain Links.....	191
5.1 Round Links	191
5.2 Long Links.....	192
5.3 Oval Links.....	192
5.4 Other Types of Chain Links	192
6. Chain Material	193
6.1 Mild Steel Chains.....	193
6.2 Heat Resistant Alloy Chains	193
7. Chain Hangers	194

8. Main Characteristic Data of Chain Systems.....	197
9. ANNEXES.....	198
10. LITERATURE	203
11. Test Questions	204

Summary:

A kiln chain system has four main functions:

- ◆ It helps to increase the heat exchange between gas and raw meal
- ◆ It keeps the kiln shell (lining surface) clean
- ◆ It assists the transport of material through the kiln tube
- ◆ It helps to reduce the dust emission

A properly designed chain system must respect the changing properties of material passing through the kiln tube. In a wet process kiln the material is fed as a liquid slurry and changes its properties subsequently in several steps inside the chain system to dry preheated granules. In accordance with the changing material properties different arrangement of chains (straight curtains, spirals, garlands, etc.) have to be used for individual parts of the system to satisfy the specific requirements. Also the chain densities and the height of the free tunnel below the chains have to be selected carefully in order to reach the maximum efficiency.

The chain links can have different shapes (round, long, oval etc.), preferably round links. The chemical composition of the chains' alloy and its physical treatment (hardening) strongly influence the life time of the system.

Different types of chain hangers can be used (single or multiple hangers, with or without shackles etc.). They have to guarantee a sufficient stability, to enable an easy installation and they should as far as possible assist the function of the chains.

NOMENCLATURE

Just a few symbols and names are to be explained before starting this lecture, the other ones will be explained in the respective chapters.

Figure:

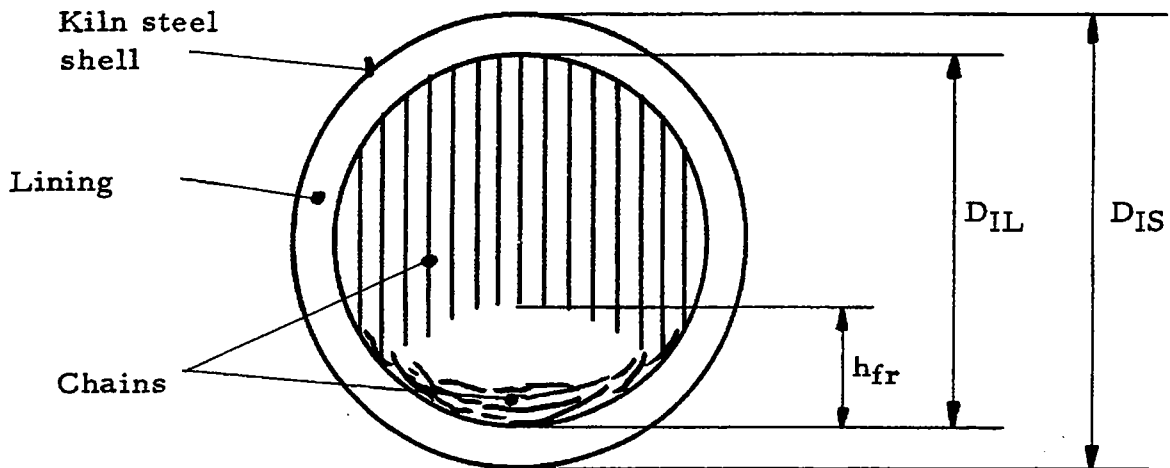

D_{is}	Diameter inside kiln steel shell
D_{il}	Diameter inside kiln lining
h_{fr}	Theoretical free height under the chains (see attached sketch), expressed in mm or as % of D_{il}
density of chains m^2/m^3	is calculated for individual parts (zones) of the system as the total surface area of chains in the respective zone divided by the volume inside lining of this zone
density of chains kg/m^3	similar to the above mentioned density, but concerns the weight of chains instead of their surface

1. INTRODUCTION

Wet process kilns cannot be successfully operated without internal kiln fittings, among which the kiln chains are the most typical and most frequently used ones. The number of existing wet process kilns is still high (~33% in "Holderbank" Group) and a conversion from wet to dry process is very expensive. By improving the existing chain systems or, where necessary, by installing a completely new chain system, the kiln operation can be upgraded considerably with relatively moderate investment costs.

2. FUNCTIONS OF A KILN CHAIN SYSTEM

The kiln chain system has 4 main functions:

2.1 Heat Exchange

The heat exchange between hot gases and the raw material depends on the surface area exposed to the hot medium. In the parts of kiln where no chains are installed, this surface area consists of the surface of the material layer on the kiln bottom and of the surface of the remaining part of the kiln shell (resp. lining). By installing the chains a large additional surface area can be gained, exceeding that one mentioned above several times (up to 10 times and more) in the respective part of the kiln. By improving the heat exchange the specific heat demand is reduced and the kiln output is increased.

In Fig. 1 different positions of a chain during one kiln rotation are shown. In position 1 the chain is exposed to the stream of hot gases and thus heated up. The cooling of the chain (which passes its heat to the layer of material) starts in position 2, continues in position 3 and ends in position 4.

Figure 1:

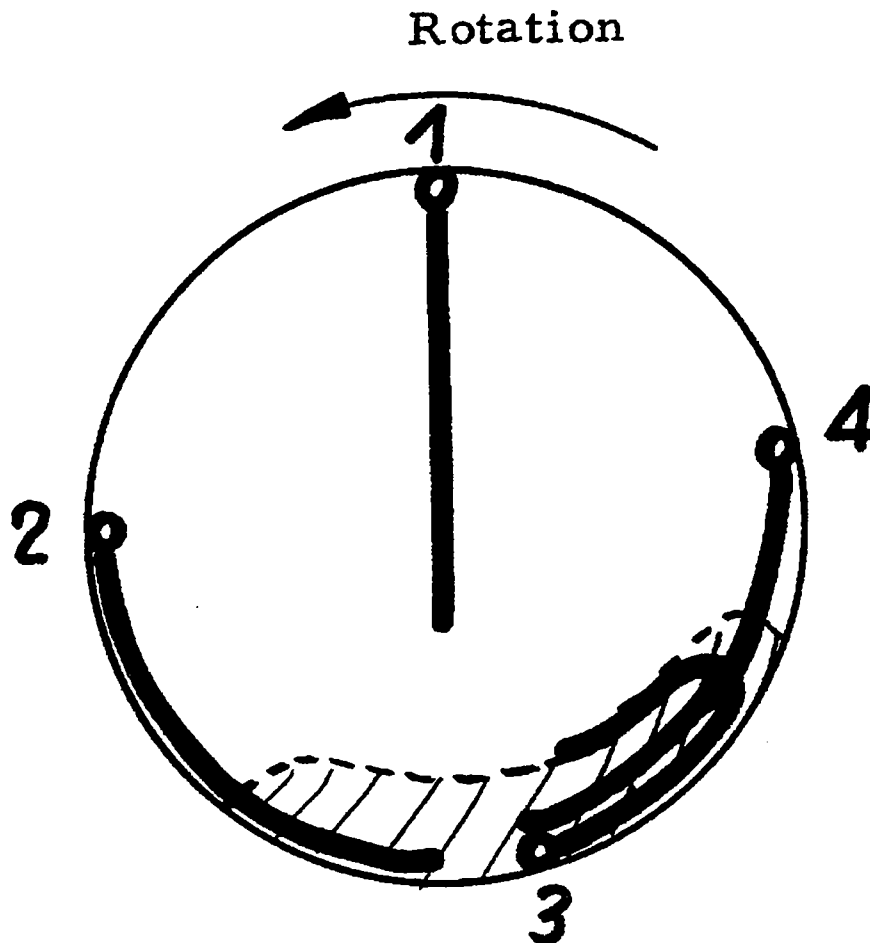

2.2 Cleaning of the Kiln Shell

In the upper part of the kiln the characteristics of the wet, sticky raw material favors the formation of mud coating and mud rings. This would reduce the free kiln cross sectional area and thus obstruct the flow of material and gases. Growing mud rings make the kiln operation difficult. It is one of the main functions of the chain system to keep the internal kiln shell surface clean, free of coating or rings. Due to the kiln rotation the chains slide on the kiln shell (resp. lining) and destroy the rings and the coating. The sliding movement of a chain cleaning the kiln shell is shown in Fig. 1 (position 3).

2.3 Transport of Material

The properties of material in different parts of the kiln differ considerably. In some sections of the upper part of the kiln, where the material is sticky and plastic, its transporting is more difficult than in other sections.

As a regular flow of material is of an eminent importance for a smooth kiln operation, it is necessary to install material flow assisting devices in some sections. Some special arrangements of chains can help to draw the material through the critical sections. This can be achieved by chains moving in the desired direction (garlands) or by a screw shaped arrangement of the chain fastening points. Other arrangements of chains can be an obstruction to the flow of material and should therefore never be used in the critical sections.

2.4 Reduce Dust Emissions

The gases leaving the kiln contain a certain amount of dust consisting mainly of partly calcined, hot raw material. The dust load of gases depends on the properties of the raw material and on the specific conditions of the kiln operation. Dust loss should be kept small, it means a loss of heat and material. The kiln chain system, mainly its upper part, can help to reduce the dust emission. Dust particles carried by the stream of gases stick to the wet surface of chains and later when these chains are emerged into the layer of material, this dust is passed over to the slurry.

3. INDIVIDUAL ZONES OF A CHAIN SYSTEM

The material passing the chain system changes subsequently its properties - it loses water and is heated up. According to the different material properties the total chain system can be divided into several zones. These zones are:

3.1 Free Zone of the Kiln Inlet

This short zone is considered to be a part of the chain system in spite of the fact that no chains are installed here. A sufficient amount of slurry should be accumulated in this zone in order to guarantee a constant and regular flow into the lower parts of the system.

Good results have been obtained with the zone length of 1 to 1.5 kiln diameters.

3.2 Dust Curtain Zone

The dust curtain zone is relatively short, its length does not exceed $0.5 D_{IL}$ under normal conditions.

The material entering this zone still has the relatively good flow properties of the kiln feed (slurry). When leaving this zone, the material has a lower water content and becomes more "plastic", essentially due to the inter-mixing of the dust previously retained by the chains in this zone.

In order to achieve a good dust catching efficiency, the density of chains must be high (some 8 to $15 \text{ m}^2/\text{m}^3$) and the free height below the chains should be $18 - 27\%$ of D_{IL} .

3.3 Plastic Zone

The length of this zone depends on properties of raw material, slurry moisture, characteristics of the kiln operation etc. and can vary in a wide range (approx. between 1.5 and 4 D_{IL}). The material in this zone is plastic and sticky, still relatively cold and wet and because of these properties it favors mud coating and mud ring formation. The transport of material through this zone is the most difficult one among all the zones of the chain system.

Due to the material properties mentioned above the chains in this zone must have a good shell cleaning and material transporting efficiency. The density of chains should be relatively low, some 5 to 8 m^2/m^3 . As to achieve a big free tunnel under the chains, the free height h_{fr} should be approx. 30% or, if garland chains are installed in this zone, some 40%. Heavier (thick wire) chains should be installed.

In order to be sure that the zone of plastic material will always stay inside the zone of chains which can treat it successfully, the respective arrangement of chains should be slightly extended in the downstream direction as to obtain a sufficient safety.

3.4 Granular Zone (Preheating Zone)

The recommendable length of this zone depends on the desired material temperature and the rest water content at its discharge end. Good results have been achieved with a zone length between 2 and 4,5 D_{IL} .

The material entering this zone is not plastic any more, it forms granules which are easy to be transported and do not favor a mud ring formation. The granules should be dried and heated up in this zone.

The chains should heat the material gently without unnecessary dust generation, they should enable a good heat exchange. Lighter (thin wire) chains should therefore be installed. A chain density of approx. 6 to 10 m^2/m^3 and a free height of approx. 25 to 30% can be recommended. This zone is sometimes divided into an upper and a lower part. Both parts have the same (or at least a similar) arrangement, but the lower part has a higher density of chains than the upper one. The damming effect of the lower part, caused by the thicker layer of chains on the kiln bottom, helps to increase the material retention time and improves the heat exchange.

3.5 Heat Resistant Zone

This zone is relatively short, its length does not exceed 1,5 D_{IL} . The material, dry and hot granules, can easily be transported. A very gentle treatment of the material is required in order to keep the dust creation as low as possible.

The main function of the chains is to protect the upstream part of the system against heat radiation and too high a gas temperature. Chains made of heat resistant steel should be installed in this zone. Lighter (thin wire) chains should be preferred.

3.6 Main Characteristic Data of the Individual Chain System Zones

Table 1

		Zone					
		Free	Dust Curtain	Plastic	Granular		Heat Resistant
					Upper	Lower	
Length	D_{IL}	$\leq 1,5$	$\leq 0,5$	1.5 to 4	1 to 3	$\leq 1,5$	$\leq 1,5$
h_{fr}	% D_{IL}		18 - 27	40 / 30	25 to 30		
Density	m^2/m^3		8 to 15	5 to 8	6 to 10		
Moisture	%	30 to 40		15 - 25			
Material temp.	$^{\circ}C$	20		100			<600
Chain temp.	$^{\circ}C$			<400			$<1'000$
Gas temp.	$^{\circ}C$	160 to 240					$<1'100$

Material flow

4. ARRANGEMENT OF CHAINS

Each individual zone of a chain system must have its own specific properties in order to satisfy the requirements mentioned previously.

4.1 Straight Curtain

As shown in Fig. 2, this arrangement of chains is very simple. The chain fastening points form a ring. Several straight curtains are combined to a straight curtain zone. The distance between the individual straight curtains (rings or rows) should not be too long, this would lead - in order to achieve a sufficient density - to too great a number of chains per ring and thus to big heaps of chains on the kiln bottom obstructing the flow of material.

Figure 2: Straight Curtain

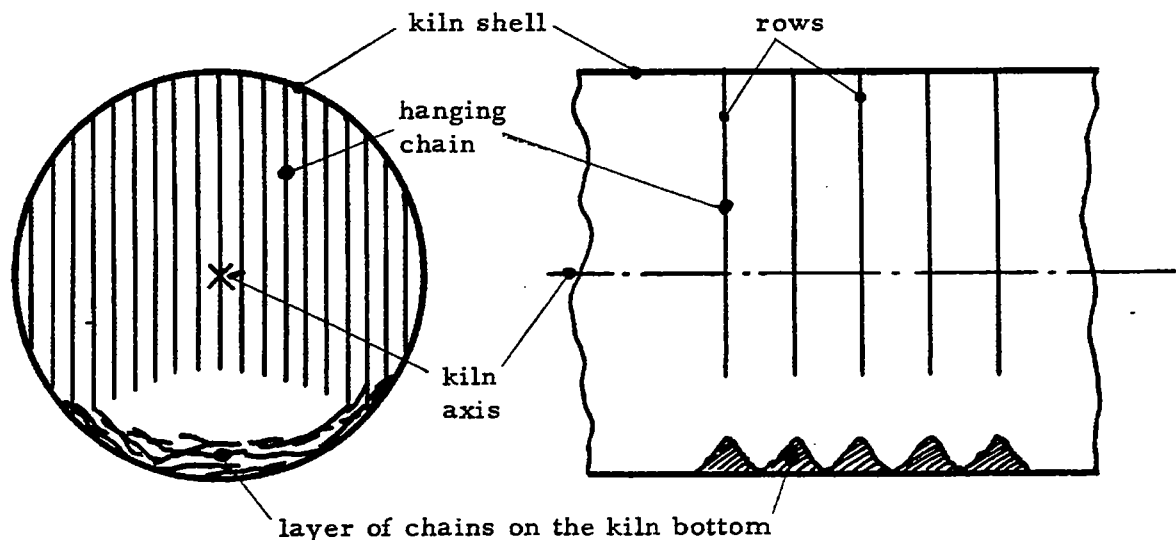

The main advantages of a straight curtain are its simple design and installation as well as an easy maintenance. Its main disadvantages are the poor shell cleaning efficiency and the fact that this arrangement does not assist the transport of material. The straight curtains should therefore not be used in the plastic zone or in the dust curtain, but they can be recommended for the granular zone.

4.2 Spiral Zone

In a spiral curtain the chain fastening points follow the screw lines on the kiln shell.

The spiral (screw) lines should have an inclination of approx. 30° (see Fig. 3). In order to assist the transport of material, the inclination must have the proper sense, i.e. the sense of rotation must be taken into consideration.

Figure 3: Spiral Curtain (4-start spiral)

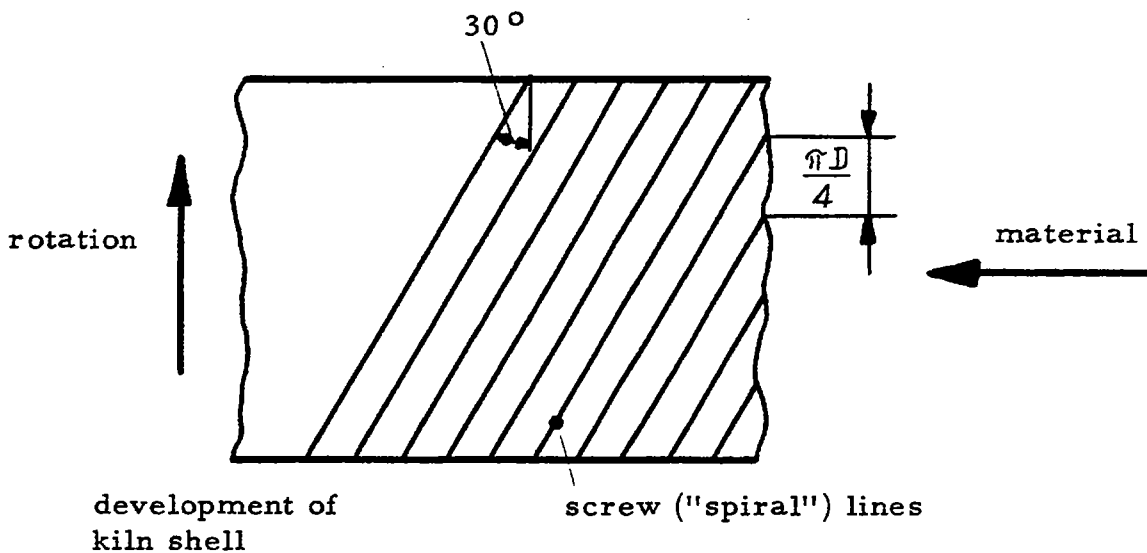

The arrangement with 4 screw lines per circumference, called a 4-start spiral, is most frequently used. This arrangement allows for a good shell cleaning effect and at the same time overlapping of chains can be avoided, as shown in Fig. 4a. The recommended chain length is namely approx. $0.7 D$, and the circumferential distance between adjacent screw lines is $\pi D/4 = 0.78 D$.

The benefits of this solution become clear if we compare it with other arrangements having a different number of screw lines. An arrangement with less than 4 screw lines per circumference (Fig. 4b) does not enable a full shell cleaning effect, because some parts of the shell have no contact with a chain. An arrangement with more than 4 screw lines leads necessarily to overlapping of chains (Fig. 4c) and thus to a higher layer of chains on the kiln bottom which is not favorable for the transport of material.

Figure 4a-c:

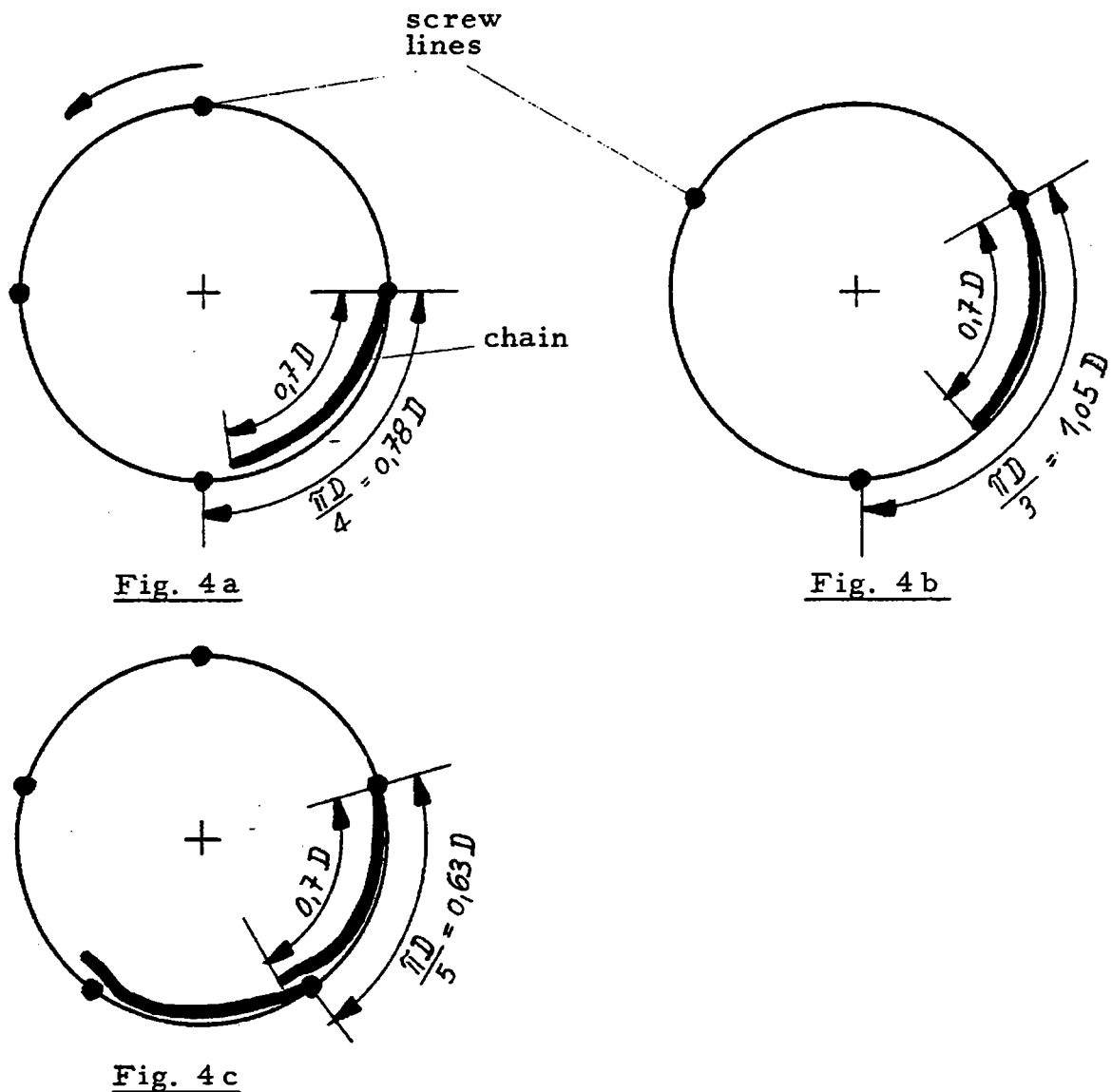

The very good material transporting and the good shell cleaning efficiency are the main advantages of a spiral curtain. Its disadvantages are a slightly smaller heat exchanging efficiency, a more difficult brick lining work and a limited maximum chain density. For these reasons, the spiral curtain arrangement should not be used in the granular zone but it can be recommended for the plastic zone.

4.3 Multiple Spiral Curtain

A spiral curtain having 8 or more spirals per circumference is called a multiple spiral curtain. Such an arrangement enables to achieve high chain densities and the passages between chains are narrow, therefore, it can be used in the dust curtain zone. Its material transporting efficiency is not as good as that one of a 4-start spiral, but it is still better than that one of any other arrangement enabling a similarly high chain density. A multiple spiral arrangement can therefore be recommended for dust curtain zones in such cases where the kiln feed flow properties are poor.

4.4 Triangular Curtain (Z-Curtain)

In a triangular curtain, also called Z-curtain, the chain fastening points follow a zig-zag line (see Fig. 5). This arrangement enables to reach high chain densities without obstructing the flow of material and gases too much. Because of the equal distribution of chains the heap of chains on the kiln bottom is not too high in spite of the high chain density (see Fig. 6).

Figure 5 & 6

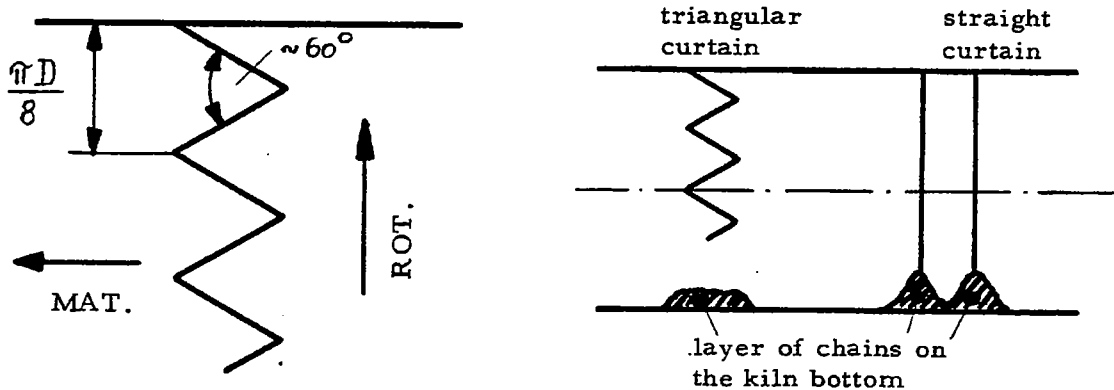

The arrangement with angles of 60° and with 8 "triangles" per kiln circumference has proved to be the most successful one. In such an arrangement the layer of chains on the kiln bottom is only approx. 4 chains high (because 8 triangles have all together 16 fastening lines and the chain length of approx. $0.73 D$ corresponds to $\approx \pi D/4$, therefore, each chain passes $16/4 = 4$ lines).

The dust catching efficiency of such an arrangement is very good, it was therefore used in the dust curtain zone in such cases where the kiln feed flow properties are relatively good. Frequently one single triangular curtain was installed, but two are also possible.

Nowadays, for dust curtains a multiple start spiral arrangement is preferred to a triangular curtain because of its material transport efficiency.

4.5 Garlands

Chains having their both ends fastened to the kiln shell are called garlands (Fig. 7) The fastening points form straight rings in the kiln shell. The shape of a garland is characterized by the chain length, by the axial distance L_{AX} and by the angle α (see Fig. 7 and 8). Good results have been achieved with an angle $\alpha \approx 90$ to 110° and a distance $L_{AX} \approx 0.5$ to $0.9 D$.

Figure 7 & 8:

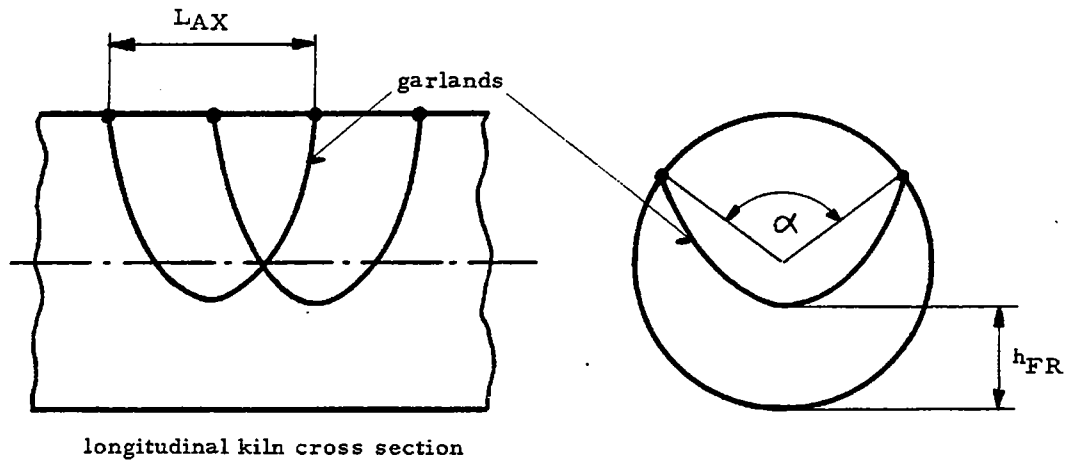

Due to the sliding movement of the garland chains on the kiln shell (resp. lining) surface, their shell cleaning and material transporting efficiency is very good and their heat exchange efficiency is approx. 1.5 times higher than that one of pending chains (see Fig. 9).

Figure 9

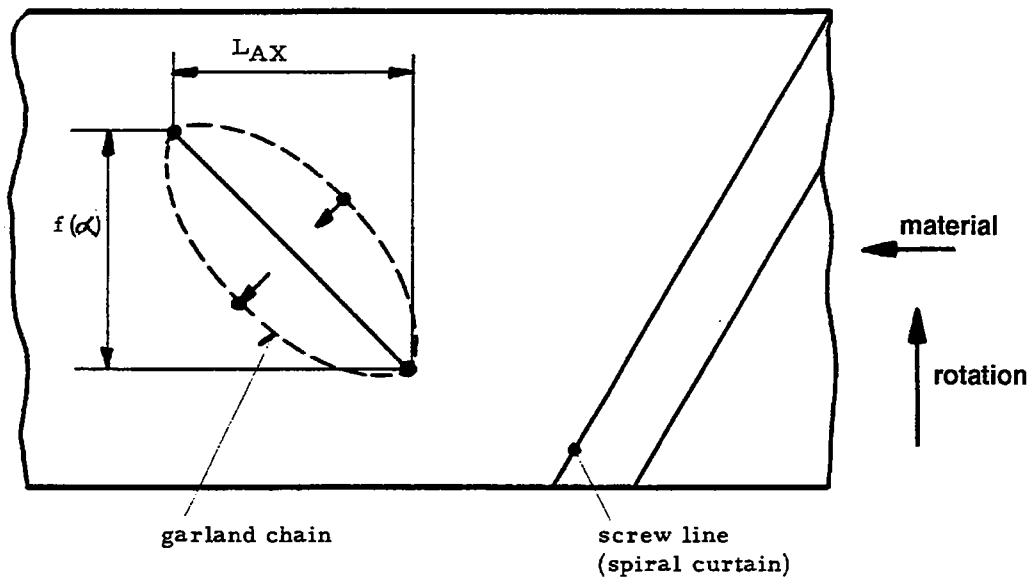

As can be seen in Fig. 9 the garland chain should be hung in a "reverse" sense, i.e. in a sense differing from that one of a screw line, in order to assist the material transport.

Due to the properties mentioned above, the garland chains have been used mainly in the plastic zone.

In spite of the advantages mentioned above CS/PT does usually not recommend the installation of garlands because of their disadvantages, namely:

- ◆ complicated installation
- ◆ difficult maintenance
- ◆ relatively short life time
- ◆ at the ends of the garland zone the shall cleaning efficiency is very poor (no movement of chain)

4.6 Festoons

Garlands without overlapping chains in the axial direction are called festoons (Fig. 10). The installation and maintenance of festoons are less difficult than that of garlands but their shell cleaning efficiency is poorer (the areas between the individual bays of festoons are not cleaned reliably).

Figure 10

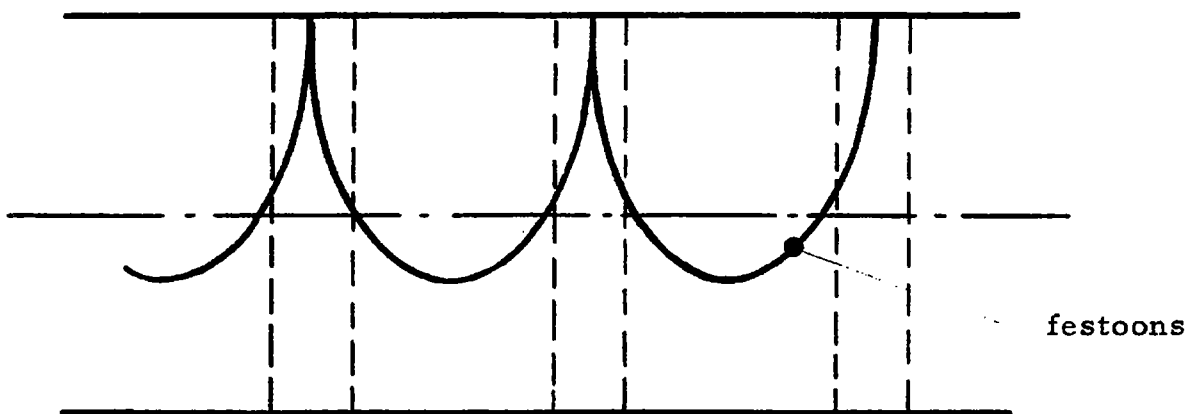

4.7 Spiral Garlands

An arrangement of garlands where the chain fastening points form screw lines ("spirals") is called spiral garlands. Its material transporting efficiency is even better than that one of normal straight garland zone, but the erection and maintenance are more complicated.

4.8 Thermochains

Thermochains are a special type of festoons, meeting the following conditions:

- ◆ The axial distance L_{AX} between the two fastening points is short (approx. 0.1 to 0.15 D_{IL}).
- ◆ The angle α between the two fastening points is approx. between 60° and 120° , preferably 90° to 120° .
- ◆ The free height under the chain h_{fr} is approx. between 0.4 D_{IL} (for $\alpha = 120^\circ$) and 0.6 D_{IL} (for $\alpha = 90^\circ$).
- ◆ The chain (shackles included, if used) is approx. 1.1 times longer than the distance between the two fastening points, measured on the lining surface (see Fig. 11a and 11b).

A good heat transfer and at the same time a gentle treatment of material preventing an unnecessary dust creation are the main advantages of thermochains. Their disadvantages are a low shell cleaning ability and a very limited material transporting efficiency. Thermochains only have a limited sliding movement on the kiln lining compared to garlands and for this reason the sense of hanging (reverse or non-reverse) does not make too much difference. Thermochains cannot be used in the upper and central part of the chain system where the shell cleaning efficiency is of an eminent importance. They should be used in the lowest (hot) part of the system in such cases when another type of chain arrangement enabling the same heat exchange would lead to an excessively high dust emission.

Figure 11a & b:

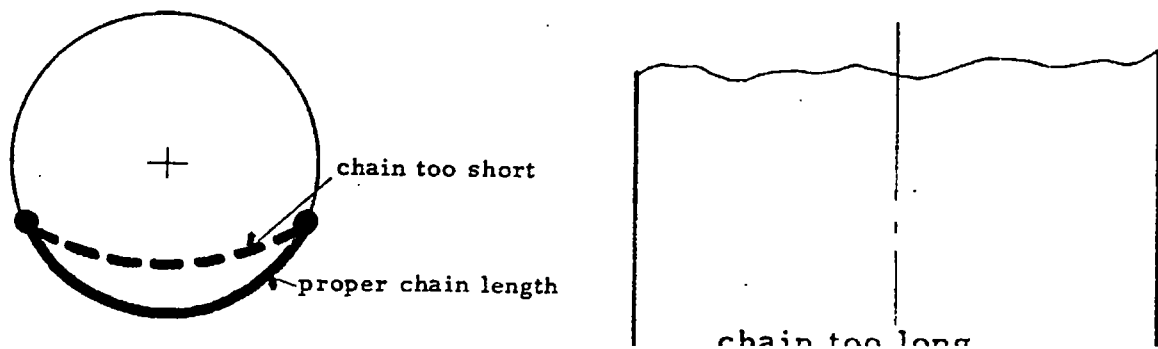

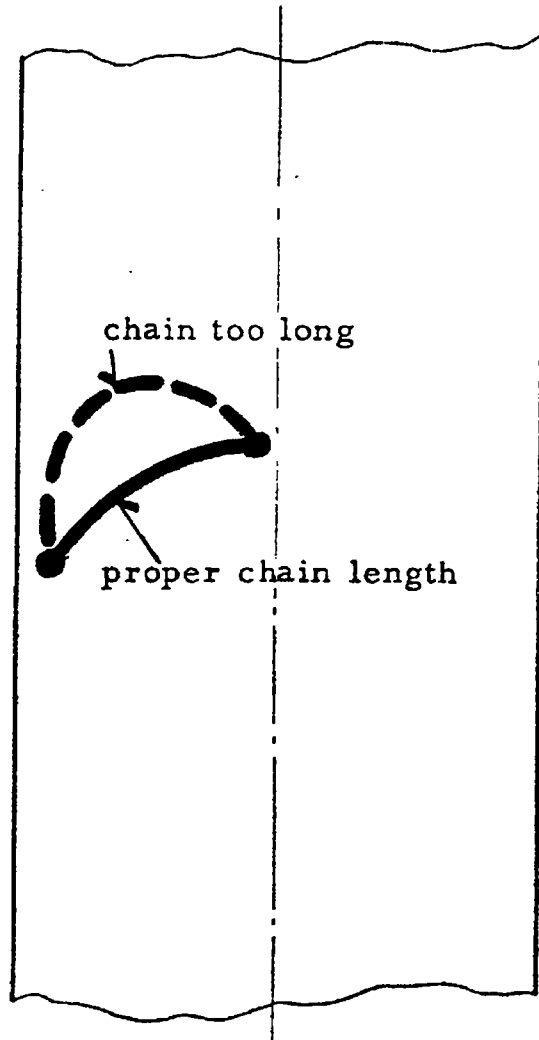

development of kiln shell .

5. TYPES OF CHAIN LINKS

5.1 Round Links

The round links (Fig. 12a) can rotate slowly when kiln is in operation which has two advantages:

- the wear is distributed equally over the whole link circumference, and therefore, in comparison with other types, round links have a longer life time.
- due to the rotation of links their surface is kept clean which enables a good heat exchange (links are not surrounded by an insulating mud layer).

Because of the properties mentioned above round links should be preferred to other types mainly in those zones where the material is wet and sticky.

For calculations of the chain surface area and chain weight, the following formula can be applied:

- ◆ surface area of 1 link $O = \pi^2 S(s + d)$
- ◆ volume of 1 link $V = 0 \cdot \frac{S}{4}$
- ◆ weight of 1 link $G = V \cdot \gamma (\gamma \approx 7.8 t/m^3)$

The above formulas are valid for round chain links with a round wire cross section.

Some chain suppliers express the mentioned specific properties as chain surface area per 1 m of chain and chain weight per 1 m of chain. These values are formulated as follows:

$$O_{1m} = O_{1m \text{ link}} \cdot \frac{1000 \text{ mmm}}{d(\text{mm})}$$

$$G_{1m} = G_{1m \text{ link}} \cdot \frac{1000 \text{ mmm}}{d(\text{mm})}$$

Therefore, if the chain weight and surface area are to be calculated from the 1m specific data, the chain length L_{CH} should be measured as shown in the following sketch:

Figure

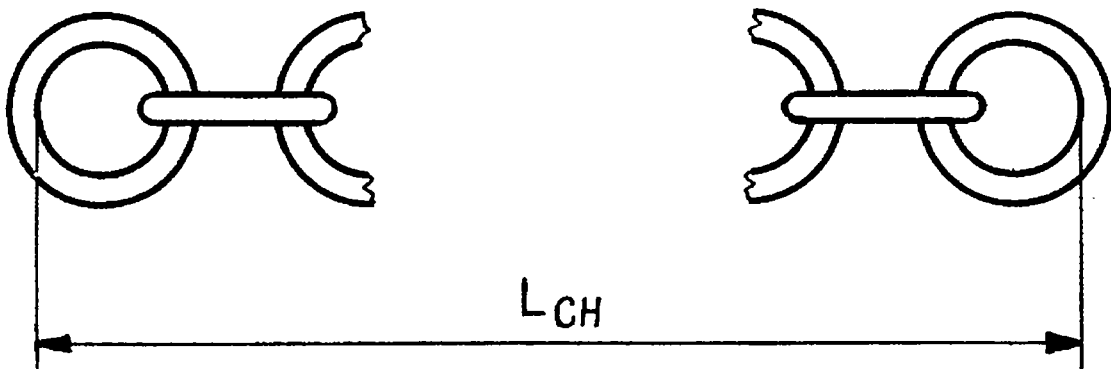

5.2 Long Links

The long links (Fig. 12b) cannot rotate like the round ones, their life time is shorter and their self-cleaning ability poorer.

For calculations of the chain surface area and chain weight, the following formulas can be applied:

◆ surface area of 1 link $O = \pi s \{2(l - d) + \pi(s + d)\}$

◆ volume of 1 link $V = 0 \cdot \frac{s}{4}$

◆ weight of 1 link $G = V \cdot \gamma (\gamma \approx 7.8 t/m^3)$

The above formulas are valid for long chain links with a round wire cross section.

5.3 Oval Links

The oval links (Fig. 12c) are similar to long links, they have similar properties and their surface area and weight can be calculated (with a negligible mistake) by means of the formulas mentioned in the part 5.2.

5.4 Other Types of Chain Links

Besides the links types mentioned above, the suppliers occasionally offer various other types of chain links such as asymmetric links, overlapping links (Fig. 12e), links with a non-round wire cross section (Fig. 12d) etc. These types are not to be recommended for cement kilns and are very rarely used, except the links with a non-round wire cross section.

Figure 12: Type of Chain Links

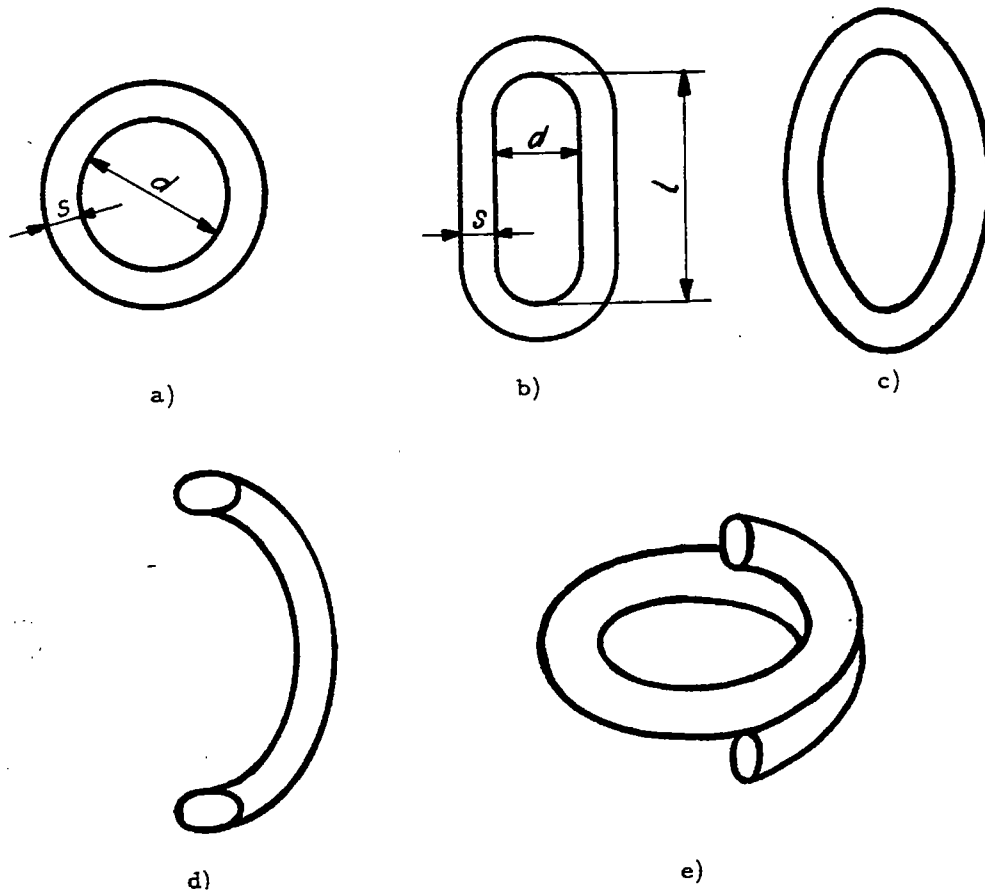

6. CHAIN MATERIAL

6.1 Mild Steel Chains

A big majority of the kiln chains are made of mild steel. In order to withstand the friction between chains, between chain and raw material, between chain and hanger etc. they have to be made of a "through hardened" steel. This hardening (result of a thermal treatment) is one of the important chain properties and only experienced kiln chain suppliers are in possession of the necessary know-how for this procedure. For this reason, even the mild steel chains should be purchased from experienced suppliers.

6.2 Heat Resistant Alloy Chains

Due to the thermal load of the kiln and the chain temperature at the hot end of the system, the portion of the heat resistant chains should be some 15% of the total weight of chains. Mild steel chains should not be installed in that part of the system where a chain temperature of 450°C or more is to be expected.

The chain suppliers offer a lot of various heat resistant steel qualities. Besides the thermal treatment the chemical composition of the respective alloy is the most important criteria. The two main components are nickel and chromium.

Nickel increases the alloy resistivity against reducing kiln atmosphere, but a higher nickel content becomes dangerous if the raw material or kiln gases contain sulphur compounds which could react with it.

Chromium increases the alloy resistivity against high temperatures, but a higher content of chromium makes the alloy sensible to sudden changes of temperature.

Above 20% Cr and at operating temperatures between 600 - 900°C an intermetallic compound can occur (-phase) which makes the alloy very brittle and causes destruction. Whether this phenomenon occurs or not depends also on the Ni-content and on other elements. Alloys which are sensitive to -phase formation must be used at working temperatures above 900°C.

Because of the properties mentioned above, it is necessary to find a compromise. Good results have been achieved with heat resistant alloys containing approx. 18 to 25% Cr and approx. 5 to 13% Ni.

7. CHAIN HANGERS

Chain hangers can be divided into 2 groups, namely single chain hangers and multiple chain hangers.

The single hangers have only one chain fastening point, the multiple hangers have several fastening points. The single chain hangers should be preferred in cases, where larger distances between the chain hanging points are desired - this solution enables to keep the weight of hangers as low as possible. (Under favorable circumstances, the weight of hangers should not exceed some 15% of the weight of the chains).

The chain can be fixed to the hanger by means of a shackle (Fig. 15). Specially designed hangers enable shackleless hanging of chains.

In Fig. 13 and 14 some examples of the chain hangers are presented, namely:

- Fig. 13 a, b, c single hangers with shackles
- Fig. 13 d single hanger, shackleless
- Fig. 13 e, f
- Fig. 14 b, c multiple hangers with shackles
- Fig. 13 g
- Fig. 14 a multiple hangers, shackleless

Figure13:

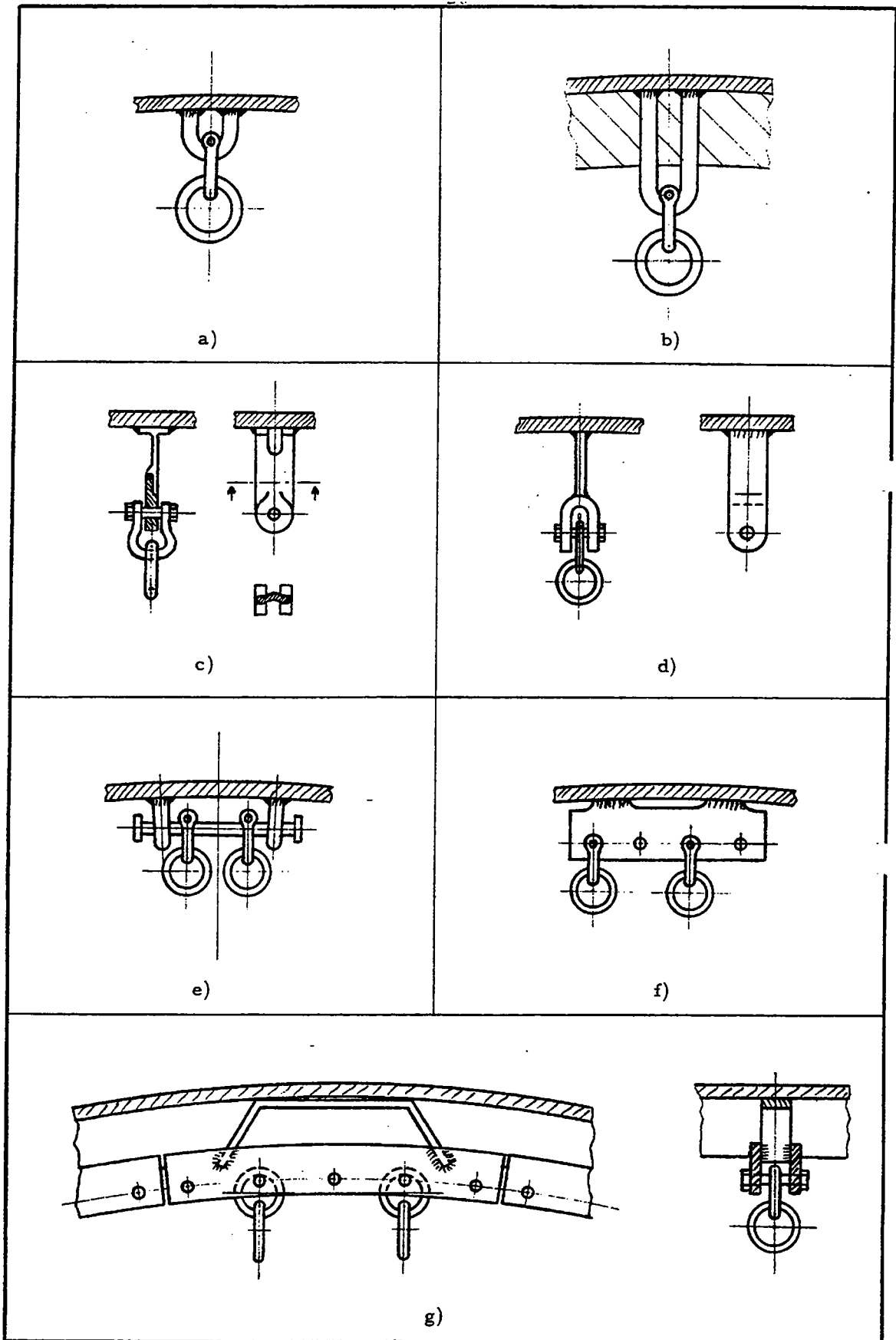
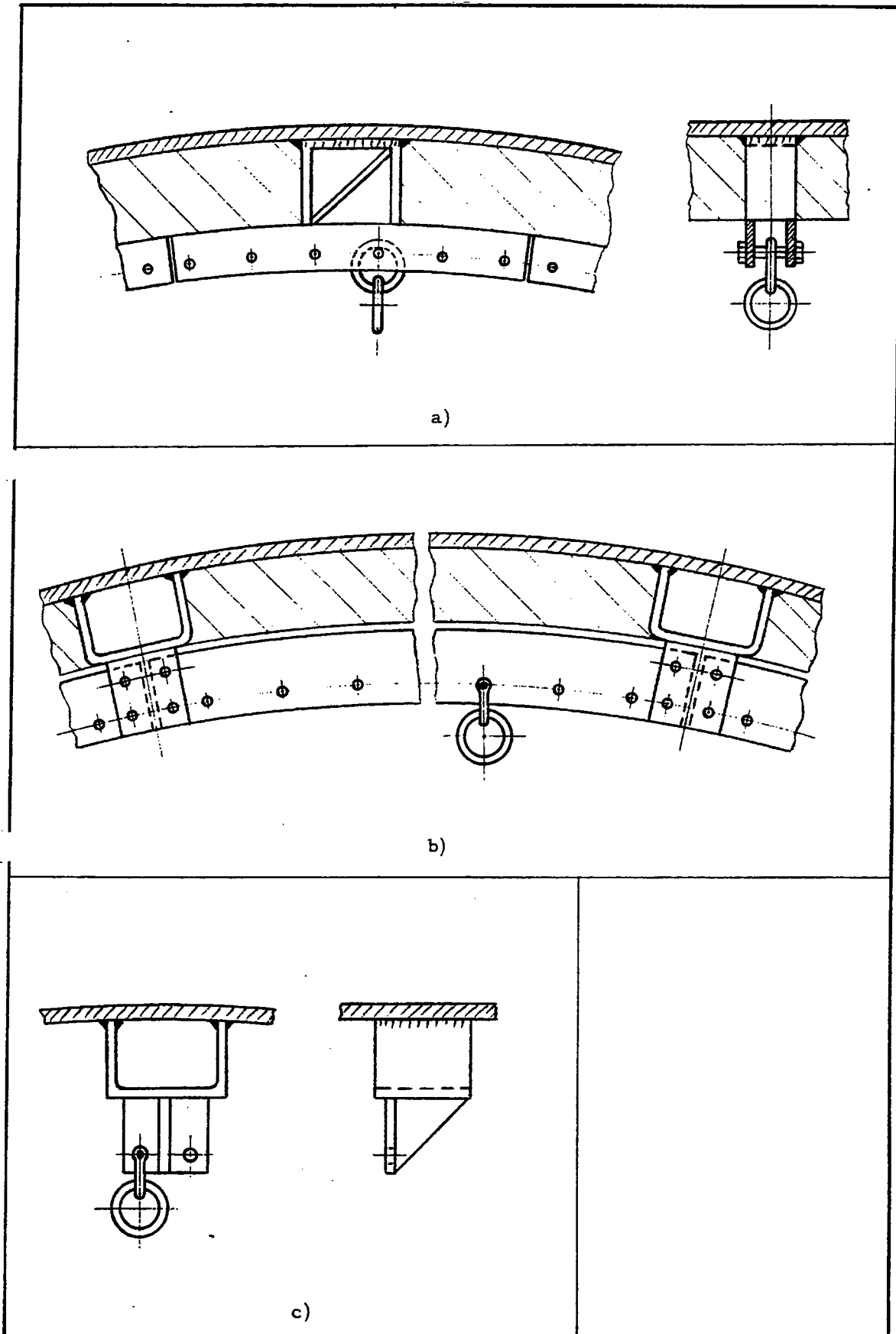
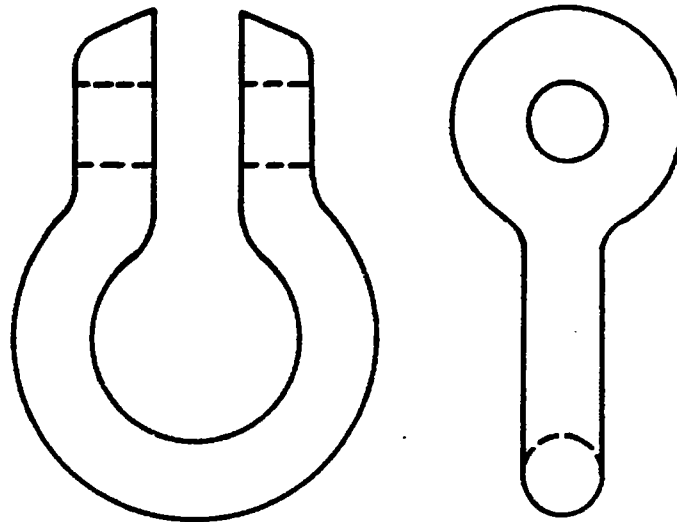

Figure 14:



The gap between the plate of a multiple hanger and the steel kiln shell should not be too wide. Gaps exceeding some 20 mm enable, when the kiln lining is worn out, penetration of chains into the space between kiln shell and hanger. This leads to tangling of chains and finally to a destruction of chains and hangers.

Figure 15: Shackle



8. MAIN CHARACTERISTIC DATA OF CHAIN SYSTEMS

The following average data are to be understood only as a very rough guideline.

Length of the total chain system	18 to 35% of total kiln length (some 6 to 10 D)
Total weight of chains: - smaller kilns (< 1000 t/d) - bigger kilns	9 to 12% of daily kiln output 11 to 20% of daily kiln output
Total surface area of chains: - smaller kilns - bigger kilns	$F_e/F_{ii}^*) = 1.1$ to 1.8 $F_e/F_i = 1.5$ to 2.6

- * F_e = total surface area of chains
- F_i = total surface area of kiln shell (inside lining)

9. ANNEXES

Annex 1: Example of chain system record keeping (DA K5)

Annex 2: Example of material sampling port arrangement on wet kiln (BP K1)

Annex 3: Example material sampling and mass balance (BP K1)

Annex 4: Example of material sampling port on wet kiln (BS K1)

Annex 1: Example of chain system record keeping (DA K5)

Darra Kiln #5 Chain System

GENERAL DATA	Production rate	750 tpd	Kiln diameter	BZ 3.9	CZ 3.4	IZ 3.9	Kiln length	141.7 m
	Heat consumption	6200 kJ/kg.ci	Mechanical load	78	106	78	Kiln surface (IL)	1460 m ²
	Kiln feed moisture	36.6 %	Thermal load	5.6	7.6	5.6	Kiln volume (IL)	1204 m ³
			Section length	32.9	62.6	46.2	Kiln load (IL)	0.62 t/m ³ .d
							45 KW/m ³	

DESIGN VALUES BEFORE FEBRUARY 95 OUTAGE

Production rate 750 tpd

	Zone	Zone		Zone	Zone	Chain		No of Links	Free Height %	Design		No. of Chain	Total Area m ²	Total Weight Tons	Pattern	
		Start m	End m			Length m	Dia IL m			Mat'l	Density m ² /m ² kg/m ³					Chain Inches
Free		141.7	135.9	5.78	3.90											
Dust	1A - 1C	135.9	133.7	2.23	3.80	MS	9.0	333	37	21%	0.75	342	227	8.4	9 start 30° spiral	
Plastic	2 - 7	133.7	123.8	9.78	3.80	MS	5.0	247	37	21%	1	588	554	27.4	4 start 30° spiral	
Preheat	8 - 10	123.9	119	4.89	3.80	MS	4.1	202	37	21%	1	240	226	11.2	1 start spiral	
Hot	11 - 15	119	110.9	8.15	3.80	MS	5.7	283	37	21%	1	560	528	26.1	1 start spiral	
Radiation	16 - 19	110.9	104.4	6.52	3.80	SS	4.1	202	37	21%	1	320	302	14.9	1 start spiral	
				37.4								2,050	1,836	88.1		
Percent of kiln length		26.4%														
Length in D _k		9.8										Fe/Fi = 1.26		11.8%	of 750 TPD Production	

REMARKS Average heat consumption in 1994 6900 kJ/kg.ci
 Average dust loss in 1994 23 %

ACTUAL VALUES BEFORE FEBRUARY 95 OUTAGE

Production rate 750 tpd

	Zone	Zone		Zone	Zone	Chain		No of Links	Free Height %	Actual			No. of Chain (Design)	Total Area m ²	Total Weight Tons	Pattern	
		Start m	End m			Length m	Dia IL m			Mat'l	Density m ² /m ² kg/m ³	Thick. %					Chain Inches
Free		141.7	135.9	5.78	3.90												
Dust	1A - 1C	135.9	133.7	2.23	3.80	MS	9.0	333	37	21%	100	0.75	100	342	227	8.4	9 start 30° spiral
Plastic	2 - 7	133.7	123.9	9.78	3.80	MS	4.5	210	37	21%	95	0.95	95	588	494	23.2	4 start 30° spiral
Preheat	8 - 10	123.9	119	4.89	3.80	MS	3.6	166	37	21%	93	0.93	97	240	200	9.2	1 start spiral
Hot	11 - 15	119	110.9	8.15	3.80	MS	3.3	145	37	21%	90	0.90	65	560	301	13.4	1 start spiral
Radiation	16 - 19	110.9	104.4	6.52	3.80	SS	3.7	173	37	21%	95	0.95	96	320	272	12.8	1 start spiral
				37.4									2,050	1,494	67.1		
Percent of kiln length		26.4%															
Length in D _k		9.8											Fe/Fi = 1.02		8.9%	of 750 TPD Production	

PROPOSED MODIFICATIONS FOR FEBRUARY 1995 OUTAGE

Production rate 750 tpd

	Zone	Zone		Zone	Zone	Chain		No of Links	Free Height %	Actual			No. of Chain (Design)	Total Area m ²	Total Weight Tons	Pattern	
		Start m	End m			Length m	Dia IL m			Mat'l	Density m ² /m ² kg/m ³	Thick. %					Chain Inches
Free		141.7	136	5.78	3.90												
Dust	1A - 1C	136	134	2.23	3.80	MS	8.7	324	36	23%	100	0.75	100	342	220	8.2	9 start 30° spiral
Plastic	2 - 7	134	124	9.78	3.80	MS	5.5	261	35	25%	95	0.95	100	735	615	28.9	4 start 30° spiral
Preheat	8 - 10	124	119	4.89	3.80	MS	4.9	227	35	25%	93	0.93	100	336	274	12.6	1 start spiral
Hot	11 - 15	119	111	8.15	3.80	MS	3.8	141	35	25%	100	0.75	100	560	351	13.0	1 start spiral
Radiation	16	111	109	1.63	3.80	SS	3.9	191	35	25%	100	1	100	80	71	3.5	1 start spiral
Radiation	17	109	108	1.63	3.80	SS	3.4	169	31	33%	100	1	100	80	63	3.1	straight curtain
Radiation	18	108	106	1.63	3.75	SS	3.1	151	27	40%	100	1	100	80	55	2.7	straight curtain
Radiation	19	106	104	1.63	3.75	SS	2.6	129	23	48%	100	1	100	80	47	2.3	straight curtain
				37.4									2,293	1,696	74.5		
Percent of kiln length		26.4%															
Length in D _k		9.8											Fe/Fi = 1.16		9.9%	of 750 TPD Production	

Annex 2: Example of material sampling port arrangement on wet kiln (BP K1)

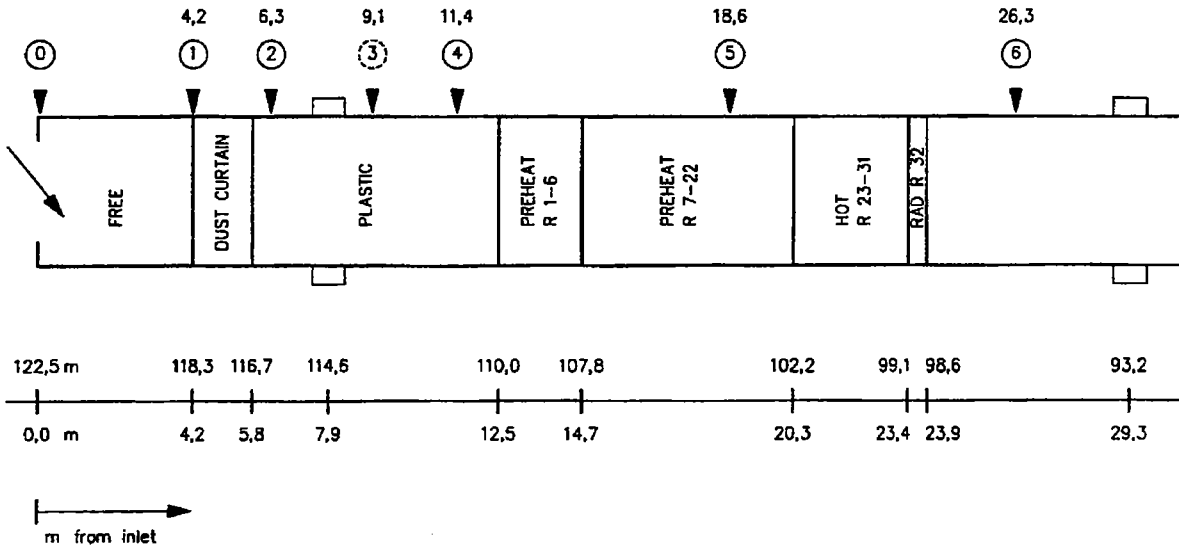

Annex 3: Example material sampling and mass balance (BP K1)

Material Properties Along Chain System

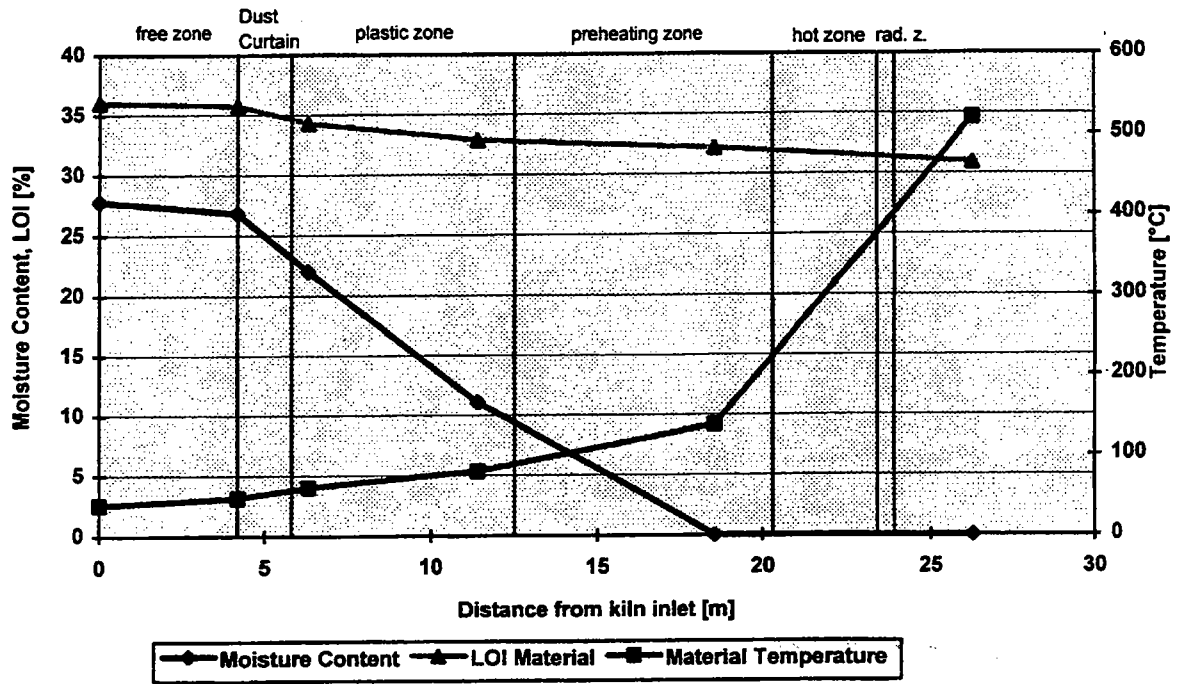

Amounts of Dust Suspended

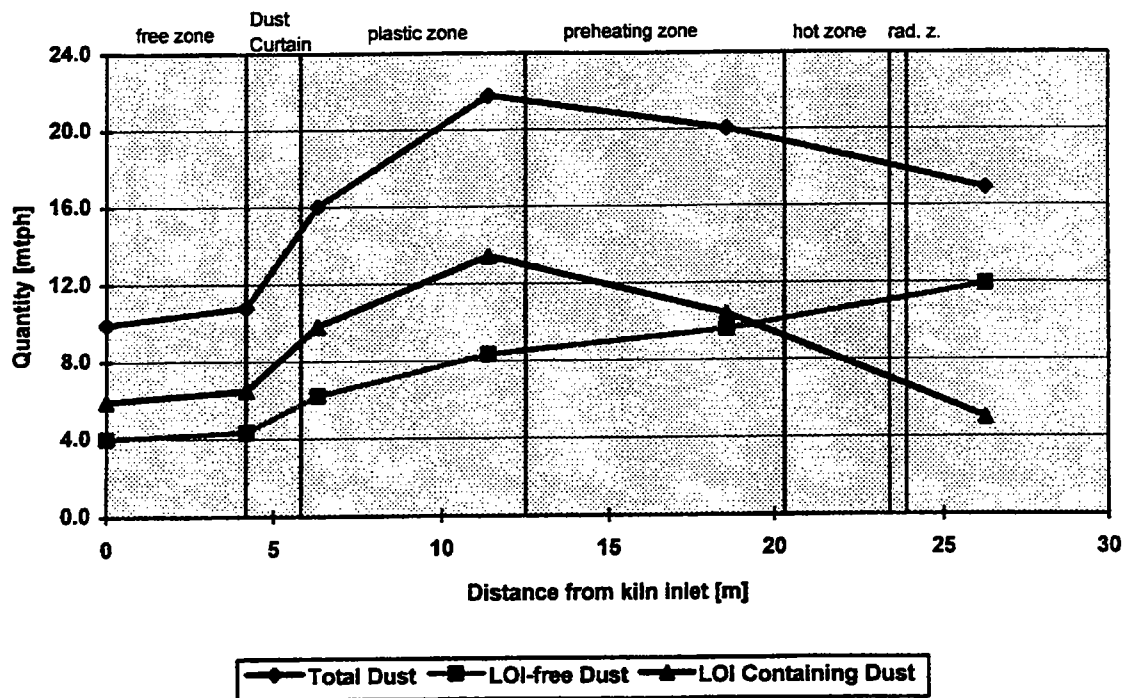

10. LITERATURE

- P. Weber Wärmeübergang und Wasserverdampfung beim Nassdrehofen
Zement-Kalk-Gips (1959), No. 5, p. 208 ff
- Legrand: Calcul des coefficients de perte de charge et de filtration d'un rideau
de chaines
Rew. Mater. Constr. (1961), No. 549, p. 327 - 332
- De Beus, Cement Technology: Design of Kiln Chain Systems Narzyski:
Rock Products 69 (1966), No. 7, p. 77 ff
- Bennet, C.S.: Chain Experience in Wet Process Kilns
Minerals Processing, Vol. 8 (1967), No. 10, p. 18 - 19
- De Beus, A.J.: Mind your Chain Dollar
Minerals Processing, Vol. 8 (1967), No. 10, pa. 12 - 17
- Feiser, C.F.: Comments on Kiln Chain Developments in the Cement Industry
Minerals Processing, Vol. 8 (1967), No. 9, p. 11 - 13
- Drayton, W.E.: Know your Kiln's Chain System
Rock Products (1972), H. 5, p. 88 ff
- Numerous TC-VA Reports
- Numerous Reports of "Holderbank" Group Plants
- "Datenbank-Blatt" Collection of TC-VA

11. TEST QUESTIONS

- 1) Name the main functions of a chain system and explain them!
- 2) According to the changing properties of material passing along the kiln tube, which individual zones do we distinguish inside of a chain system? Describe them, define the main requirements which the chains have to meet in each individual zone!
- 3) Name the different arrangements of chains and describe them!
- 4) Each arrangement has advantages as well as disadvantages, please list them!
- 5) Follow the stream of material in the kiln and define which chain arrangements can be used for the individual parts of the system! Explain why!
- 6) Explain the reverse sense of hanging garlands! Compare it to the sense of hanging thermochains
- 7) Would you recommend garlands for the downstream (hot) end of the system, thermochains for the upstream (cold) end? Please explain why!
- 8) What are the specific advantages of round link chains?
- 9) Describe the material and gas temperature profile along the system!
- 10) What portion of heat resistant steel chains would you recommend for a system? Define the main criteria for estimating this amount!
- 11) Which basic types of hangers do you know? In which case would you prefer single chain hangers?
- 12) Name the main characteristic data of a chain system: Length, total weight and total surface area of chains?